

VIPER NT



Set of Equipment supplied

- 1 Viper nt
- 1 tank lid with Quick Connector
- 1 manual

Please check whether all the products you ordered are supplied.

Content

1. Introduction	4
2. Safety instructions	5
3. Description of the parts	6
4. Fluid	8
4.1 General Notes	8
4.2 Changing the fluid container	8
5. Operating the Viper nt	8
5.1 Selecting the location	8
5.2 Putting into operation	9
5.3 Switching the device off	9
5.4 Control choices	10
5.4.1 Control via DMX 512	
5.4.1.1 Adjusting the DMX start address	
5.4.2 Control via 0 - 10 Volt (+) DC	
5.4.3 Stand alone mode	
5.4.4 Control via Radio remote	
5.5 Operating with internal timer	13
5.5.1 Auto start	
5.6 Wiring of the connectors	13
6. Cleaning, Care and Maintenance	14
7. Troubleshooting	15
8. Specifications	16
9. Warranty Conditions	17

1. Introduction

The **Viper nt** originates from the continued development and improvement of the Viper fog machine.

It unites the current digital technology with the proven technique and power of its predecessor.

New features guarantee a much more simple operation – place and fog, reducing the amount of time needed to set up the machine.

2. Safety instructions

A fog machine is not a toy!

- Very hot steam escapes from the nozzle. Danger of getting burnt.
- Occasionally very hot droplets of fluid may escape when in operation. Thus never aim at persons directly and keep a minimum distance of 3 m to the nozzle.
- Never touch the nozzle when in operation. Danger of getting burnt.
- The location for the machine must be non-flammable, non-combustible and not sensitive to heat. It has to be twice as big as the machine.
- Keep a minimum distance of 60 cm to all flammable, combustible objects and objects sensitive to heat.
- Glycol is alcohol and burns with a slightly bluish, almost invisible flame. Never point the fog at strong sources of ignition like fire or pyrotechnic effects.
- Never open the machine and leave the machine unattended when connected to a power supply.
- It is only allowed to fly/hang the machine by using the original hanging set.
- The visibility has to be more than 2 m in rooms where people walk around.
- Do not swallow the fog fluid. Keep it away from children. In case of eye contact, rinse with a lot of water. Consult a doctor should you have accidentally swallowed some fluid.
- Spilled fluid or splashed fluid droplets can cause slip hazard. Mop up the fluid and dispose of it according to regulations.
- Fog may activate smoke detectors.

Artificially-made fog can be produced in many different ways. The method used here to produce fog, with a device which works according to the vaporizer principle, is the most harmless one.

No case has so far been reported in which a sound human being has been harmed because of using our device to produce artificial fog. However, this can only be guaranteed if the professional fog generators are used accordingly, i.e. at the correct vaporization temperatures as well as with the correctly mixed fog fluid.

We, however, recommend: **People with health problems or problems of the respiratory tract or with an inclination for allergies should avoid any contact with artificially-made fog.**

3. Description of the parts

Front view

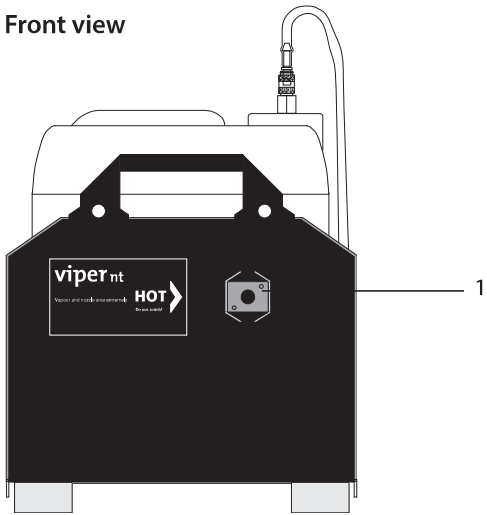

1: Nozzle

Rear view

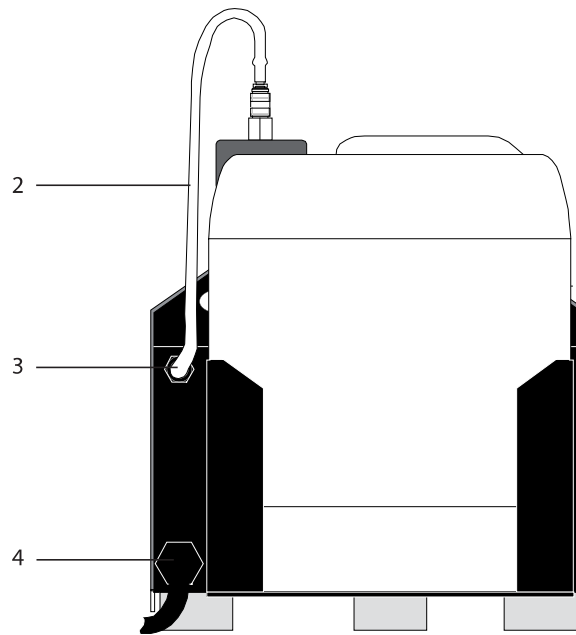

- 2: Fluid tube
- 3: Fluid tube inlet
- 4: Mains cable

3. Description of the parts

Top view

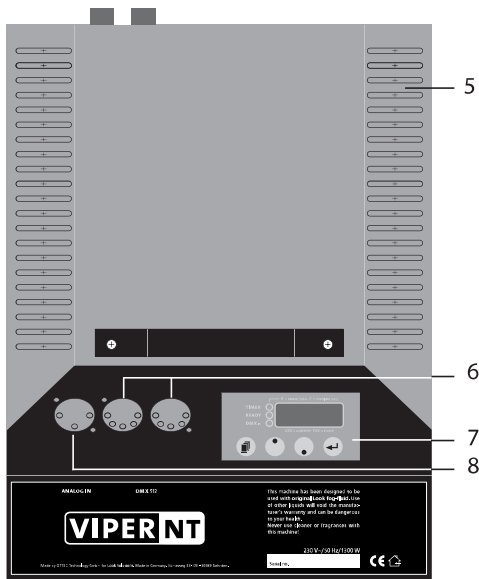

- 5: Air vents
- 6: DMX in/out
- 7: Control panel for adjusting the DMX start address and the output
- 8: XLR socket for 0-10 V (+) DC

Tank lid

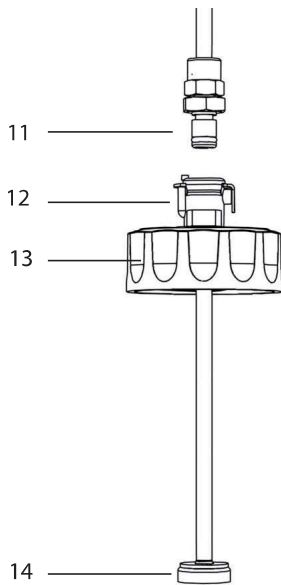

- 11: Brass coupling
- 12: Brass collar
- 13: Tank lid
- 14: Fluid filter

4. Fluid

4.1 General Notes

The **Viper nt** has been designed to be used with Look fog fluids.

The following Look fog fluids are available:

Quick-Fog	thick, quick disappearing fog fluid
Regular-Fog	thick, long lasting fog fluid
Slow-Fog	thick, extremely long lasting fog fluid

If fluids have been used other than Look fog fluids we can't grant warranty on parts that have been in contact with the fluid.

PLEASE NOTE: The vaporizer of our machines does not have to be cleaned! Cleaners, available on the market, can damage the vaporizer! We cannot grant warranty in this case.

4.2 Changing the fluid container

- Disconnect the fluid tube from the lid by pressing the brass collar [10] and removing the coupling [9].
- Remove the container from the tank housing of the **Viper nt**.
- Unscrew the lid [11] of the empty container and screw it onto the new container.
- Place the full container into the tank housing.
- Push the brass coupling [9] into the brass collar [10] until you hear a click. The brass collar is now locked firmly.

5. Operating the Viper nt

5.1 Selecting the location

The location in which the **Viper nt** is to be operated must

- be dry,
- be free from dusty or polluted air,
- be free from vibrations,
- be an non-flammable place or surface,
- be well-ventilated with fog-free air keeping the ambient operating temperature between 5° C and 45° C and the relative air humidity below 80%.

5. Operating the Viper nt

The **Viper nt** is a powerful fog generator, producing every desired effect from a tiny puff of smoke to the thickest fog.

Digital technology makes fine adjustments of the pump possible. In steps of 1% the output can be adjusted from 1-99%.

5.2 Putting into operation

- a. Connect the **Viper nt** to the mains supply. Make sure the correct voltage is selected (230V/50 Hz). A „P” and two figures appear on the display.



- b. After a warm up time of approx. seven minutes the **Viper nt** is ready to start. The green Ready-Led [22] blinks if the working temperature is reached. As soon as the final temperature is reached, the LED illuminates permanently.
- c. Adjust the required output via the control panel and press the Enter-button [18] once to start the fogging process (see point 5.4).

5.3 Switching the device off

- a. Press the Mode-button [16] til „OFF” appears on the display. After 15 seconds the machine will switch off automatically. On the right bottom edge of the display a red decimal point appear.
You can also switch off the machine within these 15 seconds by pressing the Enter-button [18].



- b. When you switch off the DMX signal, the machine will be switched off automatically after 15 seconds.

5. Operating the Viper nt

Control panel (Standard-Menu)

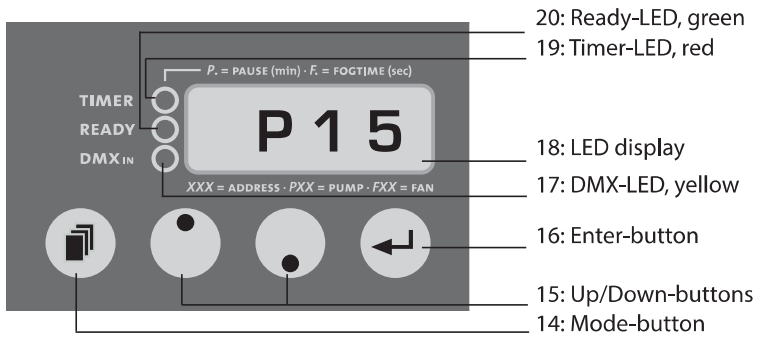

Fig. 1:
Display shown at adjusting the pump output

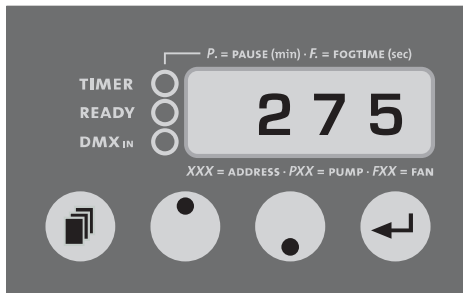

Fig. 2:
Display shown at adjusting the DMX start address

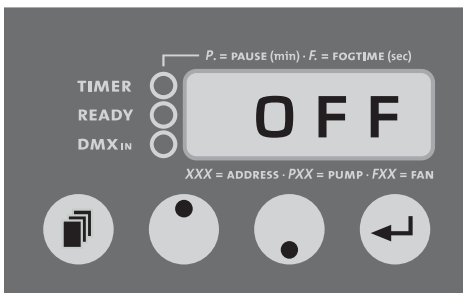

Fig. 3:
Display shown at switching off the device

5. Operating the Viper nt

5.4 Control choices

Please note: You can't use the Mode-button for scrolling through the Menu. The Mode-button has to be pressed momentarily. If the Mode-button is pressed and held more than two seconds, the machine will change into the Timer-Mode (see point 5.5).

You may control the **Viper nt** externally through the XLR sockets [6 and 8].

Please note: DMX takes priority. That means: when the machine is controlled via DMX 512 this data takes priority over 0-10 V (+) DC and Stand alone operation.

5.4.1 Operating via DMX 512

Connecting the **Viper nt** to a DMX-desk using the 5pin XLR socket [8] on the back of the machine. As soon as the machine receives a correct DMX signal, the yellow DMX-LED [17] shines.

5.4.1.1 Adjusting the DMX start address

- a) Press the Mode-button [14] at the control panel, until three figures will appear on the LED display [18].
- b) Adjust the requested start address by pressing the Up/Down-buttons [15].
- c) Save the start address by pressing the Enter-button [16] once. The start address will also be saved when you disconnect the machine from the mains supply.

5.4.2 0 - 10 Volt (+) DC control

Connect the **Viper nt** to an analog desk or with the cable remote (available as an optional extra), using the 3pin XLR socket [6] at the back of the machine.

Please note: With analog control the pump can be adjusted from the desk and/or the cable remote. The pump should be pre-adjusted at 99% at the machine.

- a) Connect the cable from the desk or the cable remote into the 3pin XLR socket at the back of the machine [8].
- b) Adjust the pump level at 99% at the machine. The knob on the cable remote or the fader on the analog desk will now control the level of the pump.
- c) Pressing the On/Off switch at the cable remote starts the fog process, the green On-LED [18] illuminates.

5. Operating the Viper nt

5.4.3 Stand alone

The Viper nt can be used in the Stand alone mode. In this mode the control of the pump must be adjusted at the machine.

- Press and release the Mode-button [14] until a „P” and two figures appear on the display [18].
- Adjust the pump output with the Up/Down-buttons [15] and press the Enter-button [16] once to start the fogging process.
The machine now produces fog until the Enter-button is pressed again.
The output can be changed during the fogging process.

5.4.4 Control via Radio remote

A radio remote is available as an option. It will be delivered with a 3pin XLR plug.

Connect the receiver of the radio remote to the machine, using the 3pin XLR socket [8] on the back of the machine.

Adjust the requested pump output at the machine (see point 5.4.3).

Press and hold the first button at the transmitter of the radio remote as long as you want fog to be produced (see manual „Radio remote”).

Control panel Timer-Menu (the red Timer-LED [19] shines)

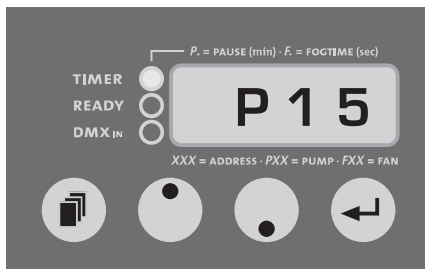

*Adjusting of the output/pump
in steps of 1% (1-99%)*

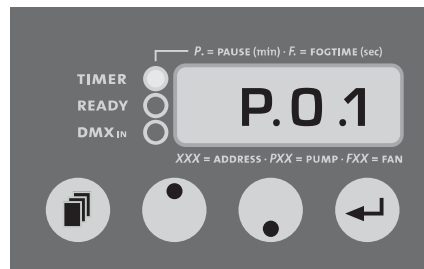

*Adjusting of the wait time
in minutes (0.1-99)*

5. Operating the Viper nt

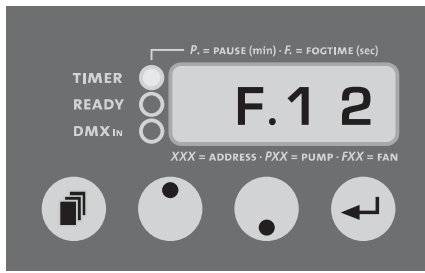

Adjusting of the fog time in seconds (1-99)



Escape to switch back to the Standard-Menu with the Enter-button

5.5 Operating the internal timer

With the internal timer the „fog time“ and “wait time“ as well as the output can be adjusted.

To start the Timer-Mode, press and hold the Mode-button [14] for more than 2 seconds. The red Timer-LED [19] shines as soon as the machine has switched to the Timer-Mode. As long as the timer is in operation, the red Timer-LED blinks.

The adjusting of the output, fog time or wait time is the same as in the Standard-Menu. That means you have to press the Mode-button until you reach the required function.

With the Up/Down-buttons you can adjust the output (Pxx), fog time (F.xx) and wait time (P.xx), then press the Enter-button to start the timer.

The timer cycle starts with the time last shown on the display (i. e. P.xx = Starts with wait time, F.xx = Starts with fog time).

You can switch back to the Standard-Menu by pressing the Mode-button [14] for more than 2 seconds or by switching to „ESC“ (Escape) in the Timer-Mode and then press the Enter-button.

5.5.1 Auto start

If the timer is in operation and you disconnect the machine from the mains cable, the **Viper nt** will re-start in the Timer-Mode as soon as it's reconnected to the mains. To stop this press and hold the Mode-button [14] for more than 2 seconds or switch to „ESC“ in the Timer-Mode and then press the Enter-button.

5. Operating the Viper nt

5.6 Wiring of the connectors

5pin XLR (DMX):

Pin 1 = Ground, Pin 2 = DMX -, Pin 3 = DMX +

3pin XLR (analog):

Pin 1 = Ground, Pin 2 = 0-10V + DC in, Pin 3 = 12V + DC out, max. 50 mA

6. Cleaning, Care and Maintenance

- Ensure the air vents [5] are not clogged by dust. If necessary remove the dust.
- Take care that the machine can not get overheated.
- Do not run the **Viper nt** without any fluid, as the pump will run dry.
- Wipe up spilled Fluid immediately. Moisture – also fluid – can destroy the electric parts of the machine.
- Check the state of the air valve filter from time to time and clean or replace it when necessary. Always replace the whole fluid canister rather than pouring new fluid into the old tank. This reduces the changes of the machine clogging up.
- If you install the **Viper nt** make 100% sure that a permanent fog-free air supply for the unit is guaranteed. Cooling air with too high fog concentration (very often in Clubs and Discos) can condense inside the machine and cause moisture damage.
- For cleaning the surface of the device use a suitable, solvent-free cleaner.
- **PLEASE NOTE:** The vaporizer of our machines does not have to be cleaned! Cleaners, available on the market, can damage the vaporizer! We cannot grant warranty in this case.

7. Troubleshooting

The fog machine **does not fog**

- Check external control signals
- Check mains supply
- Check fluid tank (empty?)
- Check for correct connections at the fluid bottle
- Check for fluid in the fluid tube
- Check if fluid filter is clogged
- Check that pump setting on the machine is >1

The fog machine **fogs uncontrollably**

- Check mains supply
- Check unit for moisture (moisture inside the machine, especially on the PCB can cause fogging)

The fog machine **switches off suddenly**

- The „Temperature cutout“ has switched off due to overheating.
Remove external heat source (for instance projector shining right onto the housing) and/or make sure sufficient fresh air supply. After 15 to 30 minutes the unit should switch back to „on“ again.

Loud droning sound during fogging

- The pump is running dry. Avoid this absolutely!
- Refill (or better: replace) fluid bottle
- Double check connection fluid tube and fluid bottle.

E-4 appears on the LED display

- The machine is getting too hot. The heating switches off and the machine cools down.
Solution: Disconnect the machine from the main supply for a moment and then re-connect it.

E	-	4
---	---	---

E-1/E-2/E-3 appears on the LED display

- Please send the machine to the service-station or your local dealer.

E	-	1
---	---	---

8. Specifications

Procedure:	vaporizing fog generator
Power requirement:	1300 Watt
Voltage:	230V/ 50 Hz or 120 V / 60 Hz
Warm up time:	approx. 7 min.
Fluid consumption:	at max. output 120 ml/min at cont. output 35 ml/min
Fluid tank capacity:	5 Liter
Fog output:	adjustable in 99 steps, steps à 1%
Output projection:	max. 15 m
Fogging time:	at 100% output approx. 30 sec. at < 50% output continuous output
external Fan:	max. 800 Watt, fan with one phase
Air quantity:	adjustable in 99 steps
Control:	DMX 512 0 - 10 V analog Timer Stand alone mode Radio remote (option) XLR-remote (option)
Temperature control:	Microprocessor controlled
Overheating protection:	Heater block/Thermostat Pump/Thermal switch
Dimensions (L x W x H):	47 x 23 x 24 cm
Weight incl. tank:	17 kg

Manufactured for:

Look Solutions GmbH & Co. KG • Bünteweg 33 • D - 30989 Gehrden • www.looksolutions.com

9. Warranty Conditions

For the fog machine **Viper nt Look'** guarantee is:

1. Free of charge, subject to the following conditions (No. 2 - 6) we will repair any defect or fault in the unit if it is caused by a proven factory fault and has been advised immediately after appearance and within 24 months of delivery to the end user. Insignificant deviations of the regular production quality does not guarantee replacement rights, nor do faults or defects caused by water, wrong fog fluid, by generally abnormal environment conditions or Force Majeure.
2. Guarantee Service will be done in the following way: Faulty parts will be repaired or replaced (our choice) with correct parts. Faulty units have to be brought to us or our service centres or to be sent to us or our service centres at customer's expense. The invoice and/or receipt showing the purchase date and the serial number has to come with the faulty unit, otherwise this will not be guarantee service. Replaced parts become our property.
3. The customer loses all rights for guarantee services, if any repairs or adjustments are done to the units by unauthorized persons and/or if spare parts are used which are not approved by us. The right of guarantee service is also lost if fluids other than original Look fog fluids have been used or if units are sent to us with full fluid bottles. Also non compliance with the instructions in this manual or mistakes by incorrect handling/treating of the machine will lead to a loss of guarantee and also any faults and damages caused by undue force.
4. Certain parts of the machine are „consumable parts“ and are not covered by the warranty.
5. Guarantee services do not cause an extension of the guarantee time or the start of a new guarantee time. The warranty for replaced parts ends with the guarantee time of the whole unit.
6. If a defect/fault can not be repaired by us in a satisfactory time, we will, within 6 months after sale of the unit, on choice of the customer, either:
 - replace the whole unit for free or
 - refund the lesser value or
 - take back the whole unit and refund the purchase price, but not more than the usual market price at the time of the refund.
7. Further claims, especially for damages, losses etc. outside the unit are excluded.

Other guarantee regulations may be valid outside Germany. Please check with your dealer!

If you should send the unit for service, do not forget to remove any liquid from the fluid bottle.

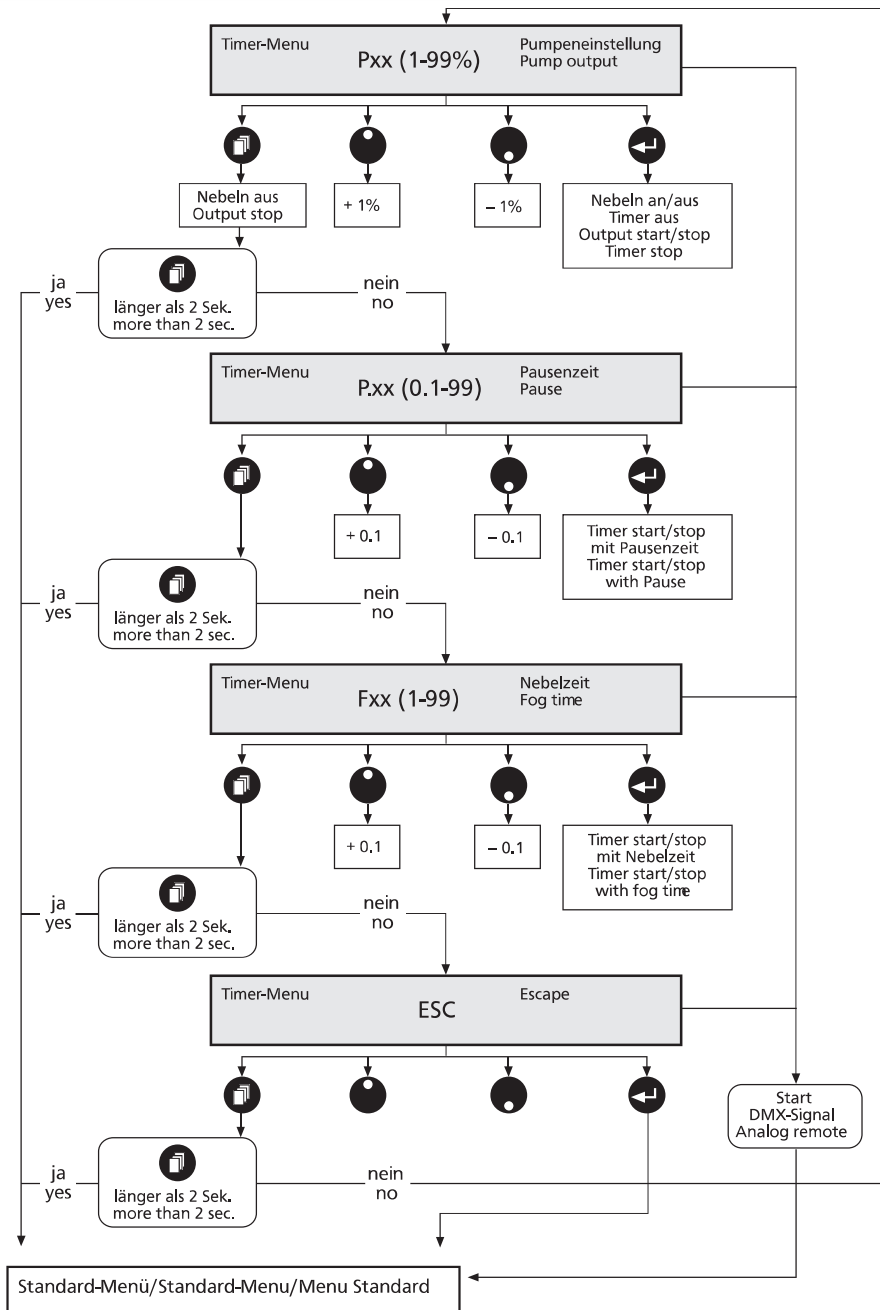



a **Look Solutions** product